

# MAXIM

## MAX1540 Evaluation Kit

**Evaluates: MAX1540**

### General Description

The MAX1540 evaluation kit (EV kit) demonstrates the standard 5A application circuit of the MAX1540. This DC-DC converter steps down high-voltage batteries and/or AC adapters, generating precision low-voltage chipset, dynamic random access memory (DRAM), and input/output (I/O) power supplies for notebook computers.

The MAX1540 EV kit provides a fixed 1.8V output voltage (OUT1), a fixed 2.5V output voltage (OUT2), and a fixed 5V, 100mA linear regulator (LDOOUT) from the 7V to 24V battery input range. It delivers up to 5A output current for each output voltage with greater than 90% efficiency. The EV kit operates at 355kHz/485kHz switching frequency (OUT2/OUT1, respectively) and has superior line- and load-transient response.

This EV kit is a fully assembled and tested circuit board. It also allows the evaluation of other output voltages in the 0.7V to 5.5V range by changing resistors R21 and R22 for OUT1, and resistors R19 and R20 for OUT2.

### Features

- ◆ 7V to 24V Input Voltage Range
- ◆ Fixed 2.5V and 1.8V Output Voltages (Adjustable from 0.7V to 5.5V)
- ◆ Fixed 5V/100mA Linear Regulator
- ◆ 5A Output Current for Each Output
- ◆ 355kHz (OUT2) and 485kHz (OUT1) Switching Frequency
- ◆ Selectable Inductor Saturation Protection
- ◆ Separate Power-Good Outputs
- ◆ Selectable Overvoltage/Undervoltage Protection
- ◆ Low-Profile Components
- ◆ Fully Assembled and Tested

### Ordering Information

PART	TEMP RANGE	IC PACKAGE
MAX1540EVKIT	0°C to +70°C	32 Thin QFN 5mm x 5mm

### Component List

DESIGNATION	QTY	DESCRIPTION
C1	0	Not installed (1812)
C2, C3	2	10 $\mu$ F, 25V ceramic capacitors (1812) Taiyo Yuden TMK432BJ106KM TDK C4532X7R1E106K
C4, C6	1	220 $\mu$ F, 4V, 25m $\Omega$ low-ESR capacitors Sanyo 4TPE220M
C5, C7	0	Not installed (case D)
C9, C11, C18	3	1 $\mu$ F, 10V X7R ceramic capacitors (0603) Murata GRM188R61A105K Taiyo Yuden LMK107BJ105KA TDK C1608X5R1A105K
C10, C14, C17	3	0.1 $\mu$ F, 25V X7R ceramic capacitors (0603) Murata GRM188R71E104K TDK C1608X7R1E104K
C12	1	0.22 $\mu$ F, 16V X7R ceramic capacitor (0603) Taiyo Yuden EMK107BJ224KA TDK C1608X7R1C224K
C15	1	10 $\mu$ F, 10V tantalum capacitor (case B) AVX TAJB106M010 Kemet T491B106M010AS

DESIGNATION	QTY	DESCRIPTION
C16	0	Not installed (0805)
C23	1	4.7 $\mu$ F, 25V X7R ceramic capacitor (1210) TDK C3325X7R1E475K
C24, C25	0	Not installed (0603)
D1, D2	2	2A, 30V Schottky diodes Central Semiconductor CSMH2-40M
D3	1	100mA, 30V, dual Schottky diode Central Semiconductor CMPSH-3A
JU1, JU2, JU3	3	3-pin headers
JU4, JU5	2	4-pin headers
L1	1	2.2 $\mu$ H, 7.5A power inductor Sumida CDRH105-2R2 Sumida CDEP104(L)-2R2
L2	1	4 $\mu$ H, 6.2A power inductor Sumida CDEP105(S)-4R0
N1, N3	2	n-channel MOSFETs (SO8) Fairchild FDS6612A
N2, N4	2	n-channel MOSFETs (SO8) Fairchild FDS6670A

# MAX1540 Evaluation Kit

## Component List (continued)

DESIGNATION	QTY	DESCRIPTION
R1, R2	2	0.010Ω ±1%, 0.5W resistors (2010) IRC LR2010-01-R010-F Dale WSL-2010-R010F
R3	1	20Ω ±5% resistor (0603)
R4, R7, R10, R13, R16, R20, R22	0	Not installed (short PC trace) (0603)
R5, R6, R8, R9, R11, R12, R17, R18, R19, R21, R23–R27	0	Not installed (0603)
R14, R28	2	100kΩ ±5% resistors (0603)
R15	0	Not installed (short PC trace) (1206)
U1	1	MAX1540ETJ (32-pin TQFN 5mm x 5mm)
None	1	MAX1540 PC board
None	5	Shunts
None	4	Rubber bumpers

## Quick Start

### Equipment Needed

- 7V to 24V power supply, battery, or notebook AC adapter
- Dummy loads capable of sinking 5A
- Digital multimeters (DMMs)
- 100MHz dual-trace oscilloscope

### Procedure

- 1) Ensure that the circuit is connected correctly to the supplies and dummy load prior to applying any power.
- 1) Verify that the shunts are across:
  - a) JU1 pins 1 and 2 (ON1 high), JU2 pins 1 and 2 (ON2 high)
  - b) JU4 pins 1 and 2 ( $\overline{\text{SKIP}}$  high, forced PWM)
  - c) JU5 pins 1 and 3 (TON = REF, 450kHz switching frequency)
  - d) JU3 pins 1 and 2 (linear regulator enabled)
- 3) Turn on  $V_{IN}$ , input/battery power supply.
- 4) Verify that the output voltages are  $V_{OUT1} = 1.8V$ ,  $V_{OUT2} = 2.5V$ , and  $V_{LDOOUT} = 5V$ .

## Component Suppliers

SUPPLIER	PHONE	FAX	WEBSITE
AVX	843-946-0238	843-626-3123	www.avxcorp.com
Central Semiconductor	516-435-1110	516-435-1824	www.centalsemi.com
Dale-Vishay	402-564-3131	402-563-6296	www.vishay.com
Fairchild	408-721-2181	408-721-1635	www.fairchildsemi.com
IRC	361-992-7900	361-992-3377	www.irctt.com
Murata	770-436-1300	770-436-3636	www.murata.com
Nihon	847-843-7500	847-843-2798	www.niec.co.jp
Sanyo	619-661-6835	619-661-1055	www.sanyovideo.com
Sumida	708-956-0666	708-956-0702	www.sumida.com
Taiyo Yuden	800-348-2496	847-925-0899	www.t-yuden.com
TDK	847-390-4373	847-390-4428	www.component.tdk.com

**Note:** Indicate that you are using the MAX1540 when contacting these component suppliers.

# MAX1540 Evaluation Kit

Evaluates: MAX1540

## Detailed Description

### Jumper Settings

**Table 1. Jumper JU1 Functions (Output-Voltage OUT1 Control)**

JU1	ON1 PIN	OUT1
1 and 2 (default)	Connected to LDOOUT.	OUT1 enabled, $V_{OUT1} = 1.8V$ .
2 and 3	Connected to GND.	OUT1 shutdown mode.
Not installed	ON1 must be driven by an external signal connected to the ON1 pad.	OUT1 operation depends on the external ON1 signal levels.

**Table 2. Jumper JU2 Functions (Output-Voltage OUT2 Control)**

JU2	ON2 PIN	OUT2
1 and 2 (default)	Connected to LDOOUT.	OUT2 enabled, $V_{OUT2} = 2.5V$ .
2 and 3	Connected to GND.	OUT2 shutdown mode.
Not installed	ON2 must be driven by an external signal connected to the ON2 pad.	OUT2 operation depends on the external ON2 signal levels.

**Table 3. Jumper JU3 Functions (Linear-Regulator LDOOUT Control)**

JU3	LDOON PIN	LDOOUT
1 and 2 (default)	Connected to LDOIN through JU3.	LDOOUT enabled, $V_{LDOOUT} = 5V$ .
2 and 3	Connected to GND.	LDOOUT shutdown mode.
Not installed	LDOON connected to voltage-divider R11/R12.	R11 and R12 set the LDOIN undervoltage-lockout threshold.

**Table 4. Jumper JU4 Functions (Low-Noise Mode)**

JU4	SKIP PIN	OPERATIONAL MODE
1 and 2 (default)	Connected to LDOOUT.	Low-noise mode, OUT1 and OUT2 are in forced-PWM mode.
1 and 3	Connected to REF.	OUT1 is in pulse-skipping mode. OUT2 is in forced-PWM mode.
1 and 4	Connected to GND.	OUT1 and OUT2 are in pulse-skipping mode.
Not installed	Unconnected.	OUT1 is in forced-PWM mode. OUT2 is in pulse-skipping mode.

**Table 5. Jumper JU5 Functions (Switching-Frequency Selection)**

JU5	TON PIN	FREQUENCY (OUT1/OUT2) (kHz)
1 and 2	Connected to $V_{CC}$ .	235/170
1 and 3 (default)	Connected to REF.	485/355 (as shipped)
1 and 4	Connected to GND.	620/460
Not installed	Unconnected.	345/255

**Note:** Do not change the operating frequency without first recalculating component values because the frequency has a significant effect on preferred inductor value, peak current-limit level, MOSFET heating, PFM/PWM switchover point, output noise, efficiency, and other critical parameters.

### Evaluating Other Fixed Output Voltages

The MAX1540 provides a fixed 1.8V output (OUT1) when FB1 is connected to GND ( $R_{21} = \text{open}$ ,  $R_{22} = 0$ ) and a fixed 2.5V output (OUT2) when FB2 is connected to GND ( $R_{19} = \text{open}$ ,  $R_{20} = 0$ ).

OUT1 and OUT2 can also be adjusted from 0.7V to 5.5V by using a resistive voltage-divider at FB1 and FB2. The MAX1540 regulates FB1 and FB2 to a fixed reference voltage (0.7V).

The adjusted output voltage is:

$$V_{OUT1} = V_{FB1} (1 + R_{21} / R_{22})$$

$$V_{OUT2} = V_{FB2} (1 + R_{19} / R_{20})$$

where:  $V_{FB1} = V_{FB2} = 0.7V$ .

Refer to the MAX1540/MAX1541 data sheet for selection of output capacitor and inductor values for various output voltages.

# MAX1540 Evaluation Kit

Evaluates: MAX1540

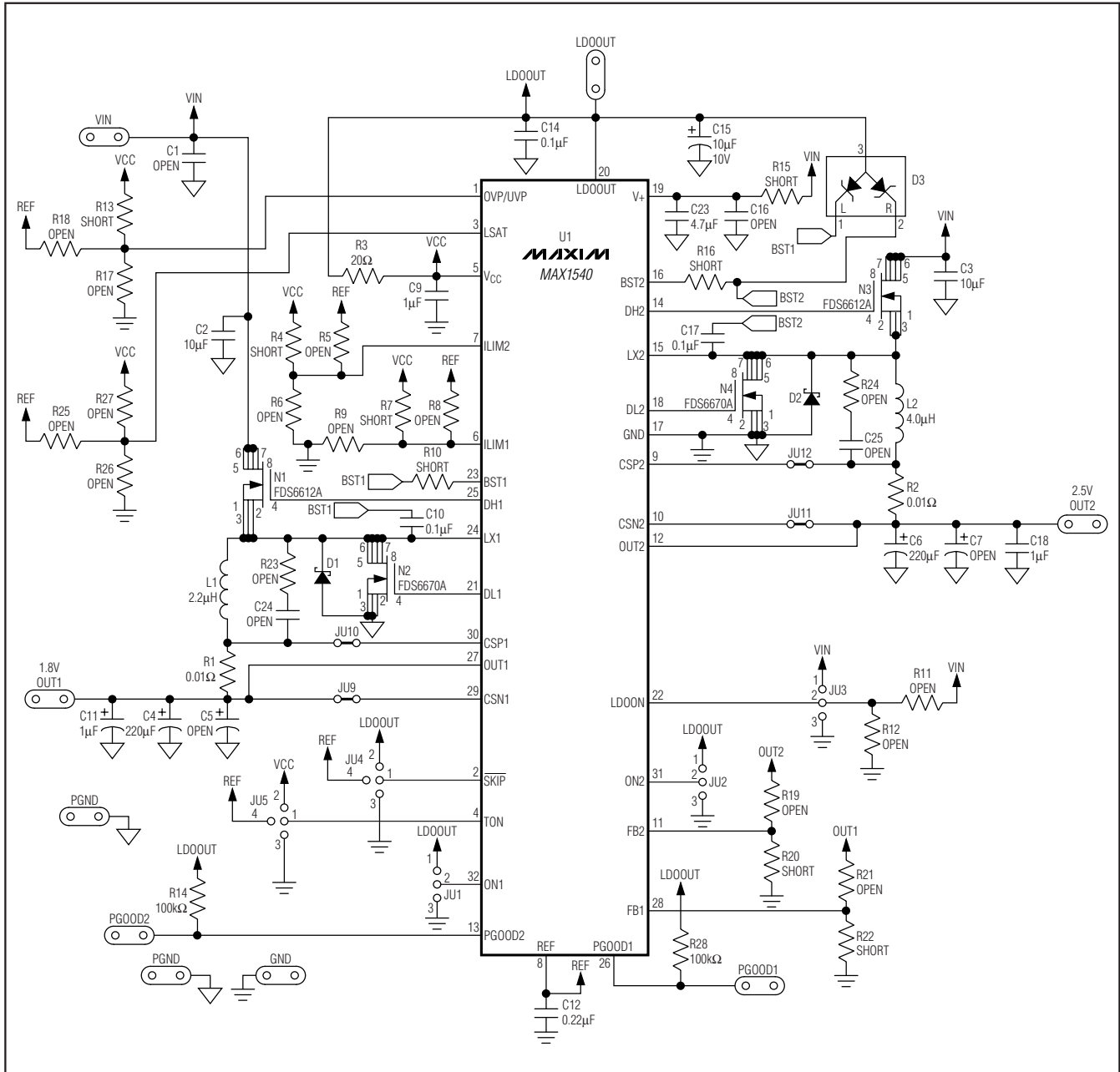

Figure 1. MAX1540 EV Kit Schematic

# MAX1540 Evaluation Kit

Evaluates: MAX1540

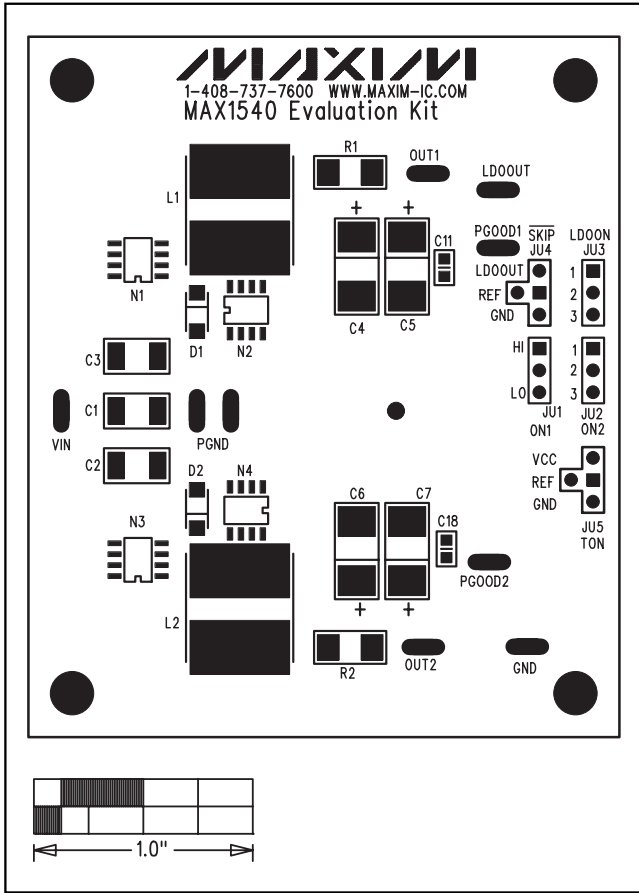

Figure 2. MAX1540 EV Kit Component Placement Guide—Top Silkscreen

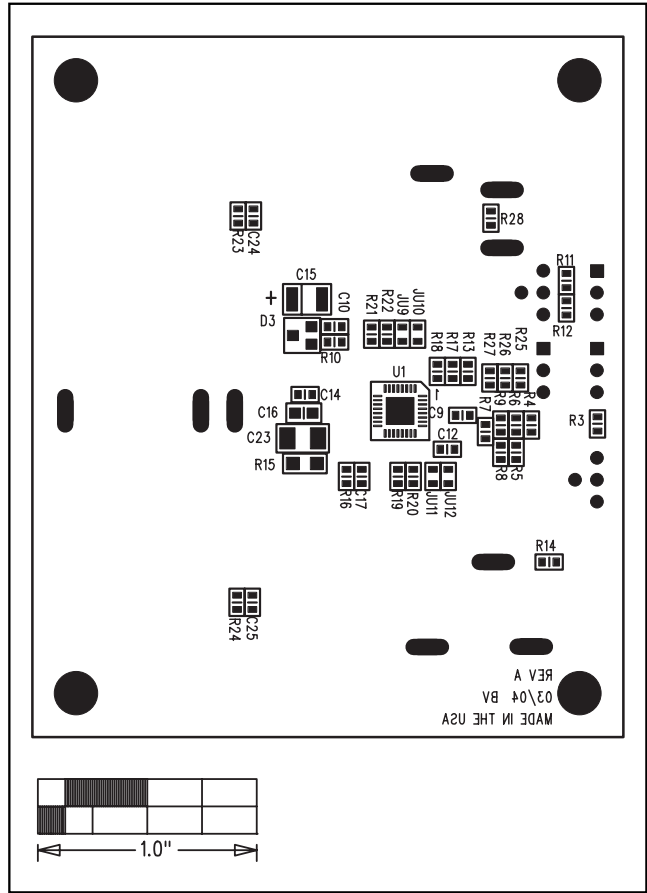

Figure 3. MAX1540 EV Kit Component Placement Guide—Bottom Silkscreen

# MAX1540 Evaluation Kit

**Evaluates: MAX1540**

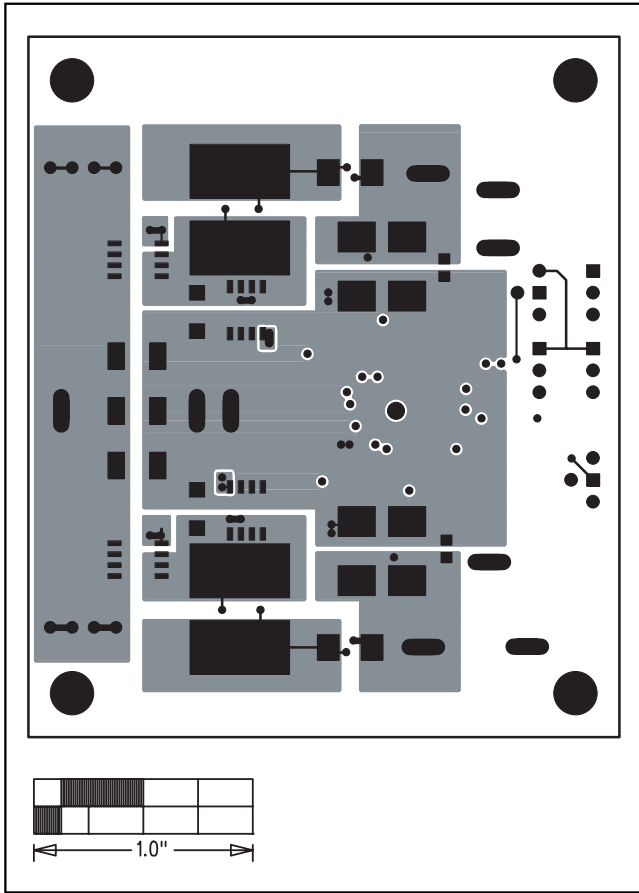

Figure 4. MAX1540 EV Kit PC Board Layout—Component Side

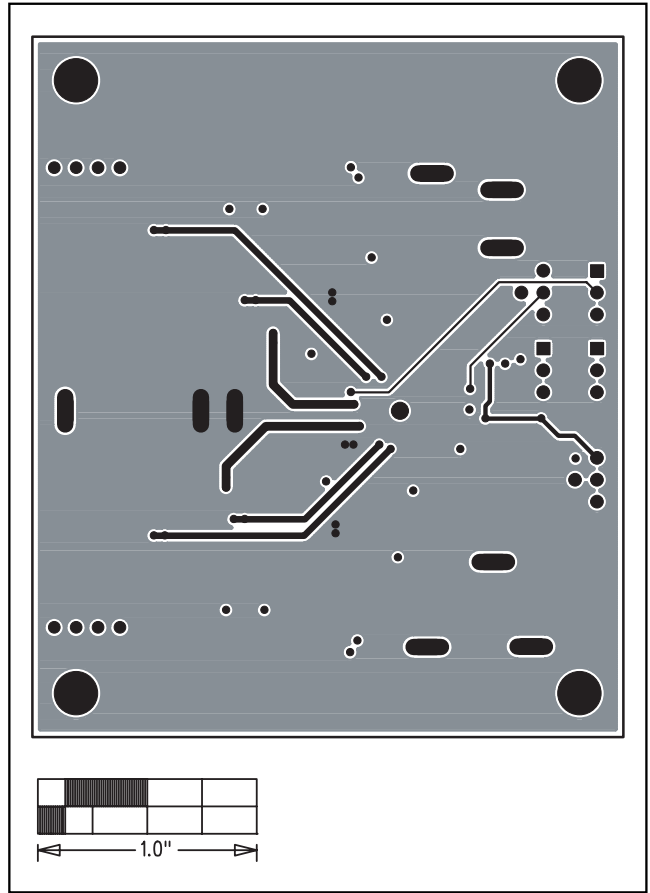

Figure 5. MAX1540 EV Kit PC Board Layout—Ground Layer 2

# MAX1540 Evaluation Kit

Evaluates: MAX1540

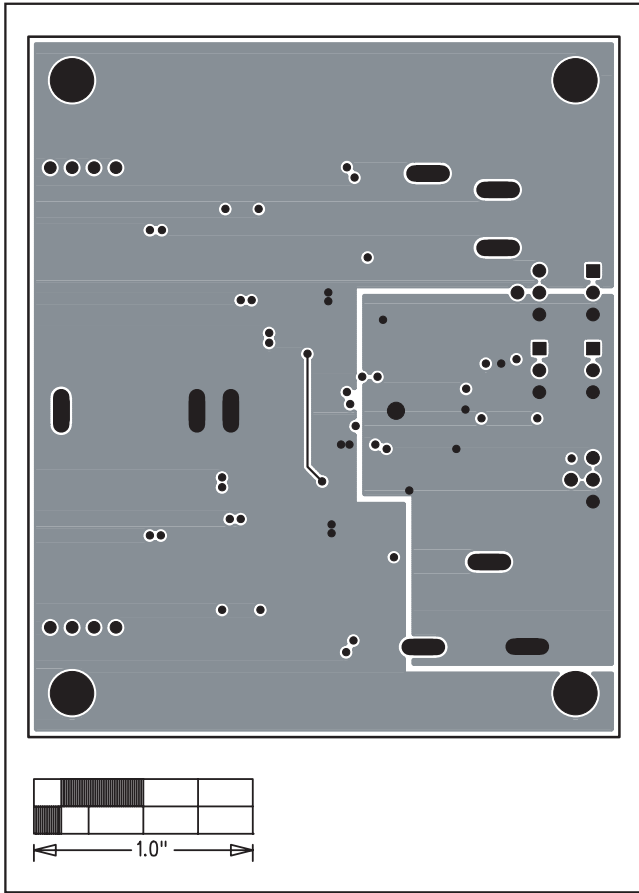

Figure 6. MAX1540 EV Kit PC Board Layout—Ground Layer 3

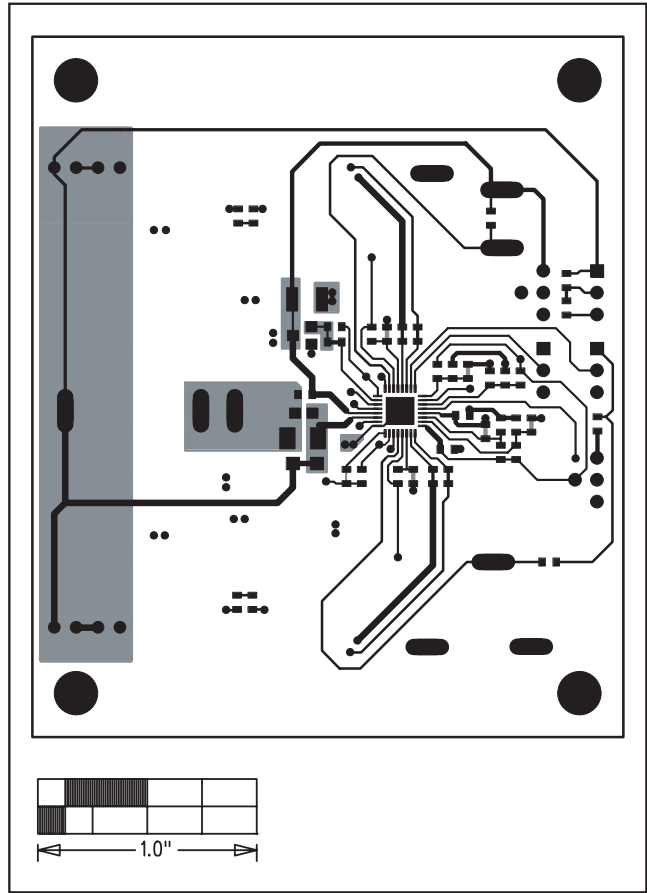

Figure 7. MAX1540 EV Kit PC Board Layout—Solder Side

Maxim cannot assume responsibility for use of any circuitry other than circuitry entirely embodied in a Maxim product. No circuit patent licenses are implied. Maxim reserves the right to change the circuitry and specifications without notice at any time.

**Maxim Integrated Products, 120 San Gabriel Drive, Sunnyvale, CA 94086 408-737-7600** \_\_\_\_\_ 7